

# “L” MOUNTS

The ERARD “L” mount range ensures to fix hertzian and parabolic antennas on a same setting up or to adapt themselves to the obligations due to the setting up area.

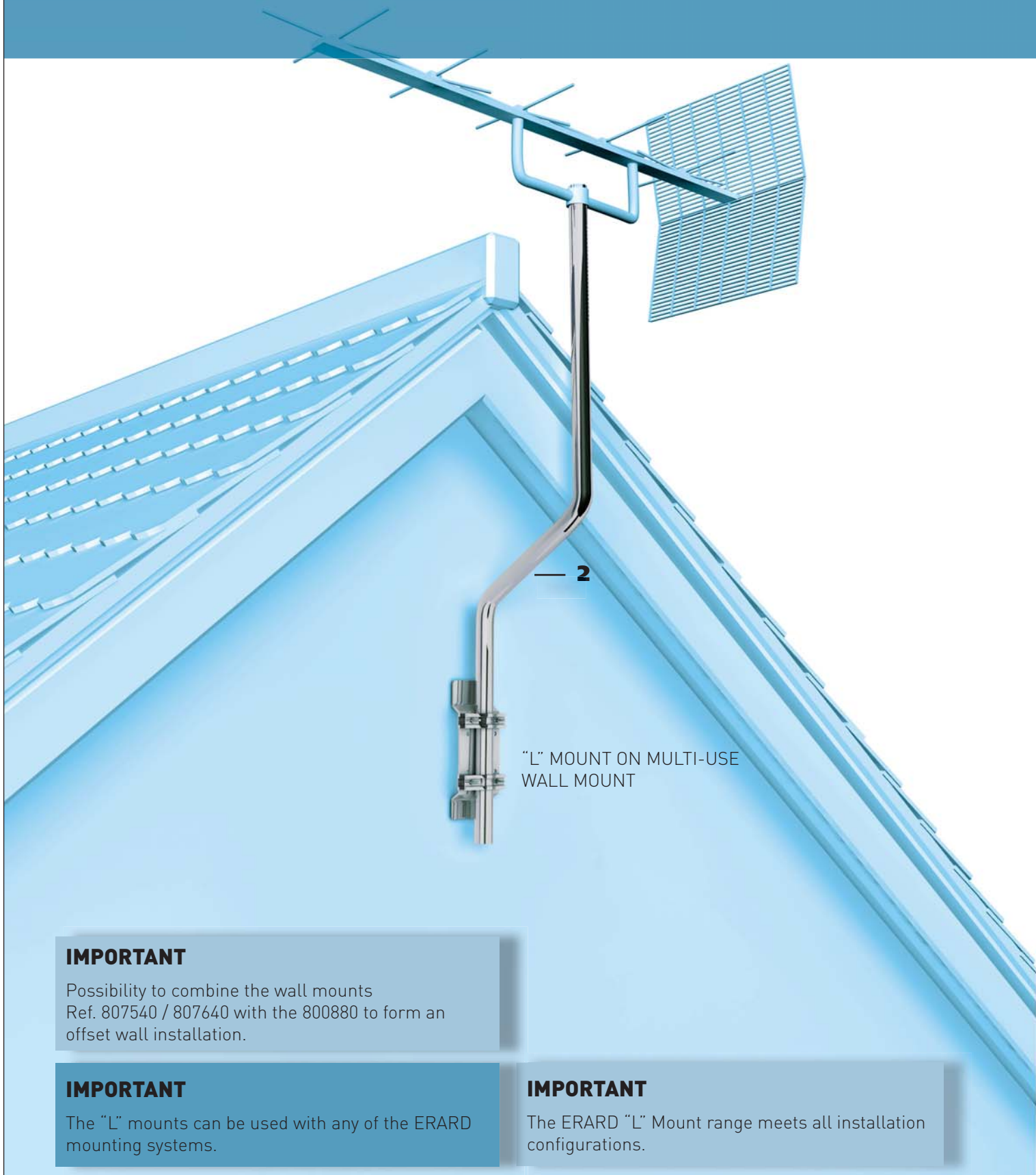

## IMPORTANT

Possibility to combine the wall mounts Ref. 807540 / 807640 with the 800880 to form an offset wall installation.

## IMPORTANT

The “L” mounts can be used with any of the ERARD mounting systems.

## IMPORTANT

The ERARD “L” Mount range meets all installation configurations.

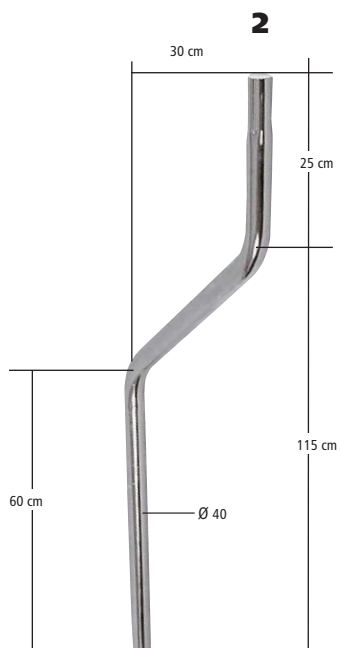
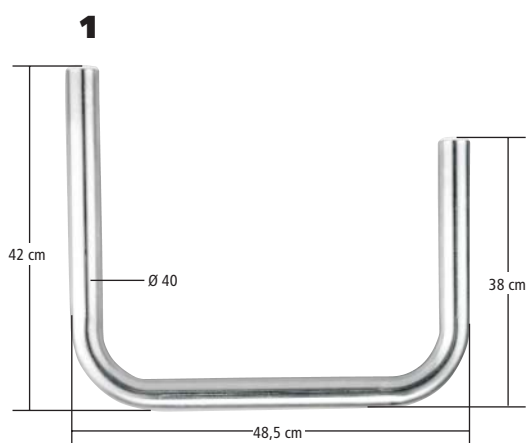

- Can be combined with the fixation Réf 800880 page 19 to form an offset wall installation.  
 - Can be combined with chimney straps and wall mounts.

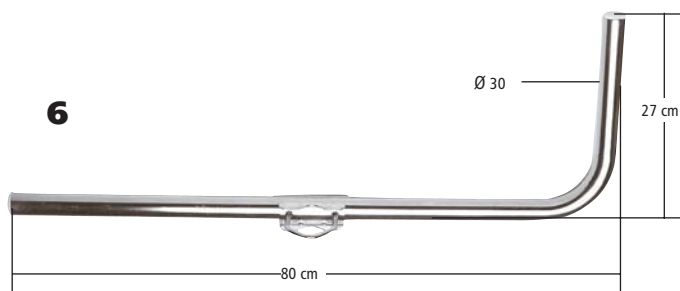
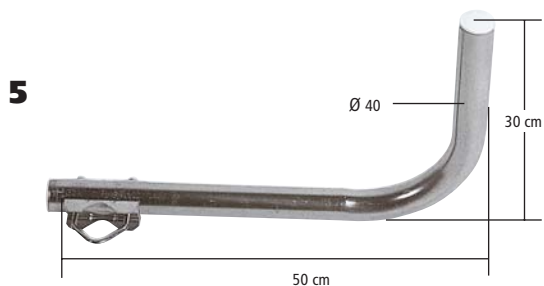
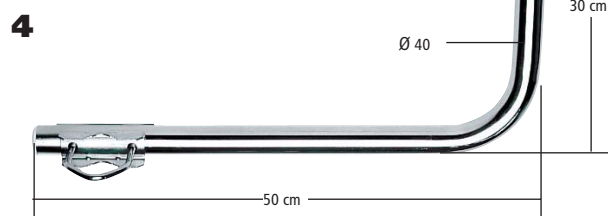
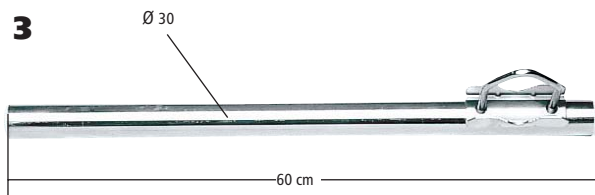

Description	White Zinc	Galvanized	Packaged Qty	Unit weight (kg)	Packaged Qty weight (kg)
	Ref.	Ref.			
1 "L" mount Ø40, length 48,5cm - Bends at lengths of 38cm or 42cm	807540		3	1,25	3,75
2 S shaped offset mount Ø40, overall length 115cm - offset 30 cm, interlocking	807640		3	1,49	4,50
3 Straight offset mount Ø 30, length 60cm	807530		6	0,80	4,80
4 "L" mount Ø 30, length 50 cm - Elbow 30 cm	807580		6	1,00	6,00
5 "L" mount Ø 40, length 50 cm - Elbow 30 cm - with 2 mast caps	807590		6	1,00	6,00
6 "L" mount Ø 30, length 80 cm - Elbow 27 cm	807630		6	1,20	7,30